



Climatization

Installation Manual



Historical

Version	Date	Author	Changes
1.0	2011-10-21		-
1.2	2015-04-03		Minor changes
1.3	2018-09-13		Branding actualization

Índex

Historical.....	2
Index.....	2
Introduction.....	3
Climatization System.....	3
Arquitecture of the Installation.....	3
Connection and Protections.....	6
Configuration.....	8

INTRODUCTION

This document is intended to orientate the work of the installer of the ONLY climatization system on the site. The next chapters explain how the installation should be made, the precautions to take and the way to test and configure the system.

It is essential to respect it in order to achieve a proper and trouble-free installation.

CLIMATIZATION SYSTEM

The ONLY climatization units are programmable thermostats that allow planning of temperatures for each weekday, for summer and winter. They act by switching on and off valves or fan coil commands or air conditioning equipment, depending on the local temperature measurement.

The system is also fed by 230V as are the automation modules, sharing the same non-isolated BUS.

This document assumes that the reader is familiarized with the electrical installation of the ONLY automation system and that the electrical installation is in accordance with its installation manual.

ARCHITECTURE OF THE INSTALLATION

ONLY provides programmable thermostats for installation in inwall boxes. Each thermostat consists of 2 parts: the actuator command that switches the valves or ventilator motor and the touch panel that has the keys and the temperature measurement.

The installer may choose to mount the actuator together with the thermostat panel in the room where the temperature is to be controlled or install the actuator near the machine to be controlled and use mixed automation/climatization panels on the automation actuators. This separation of the actuator from the panel is only possible for panels without LCD.

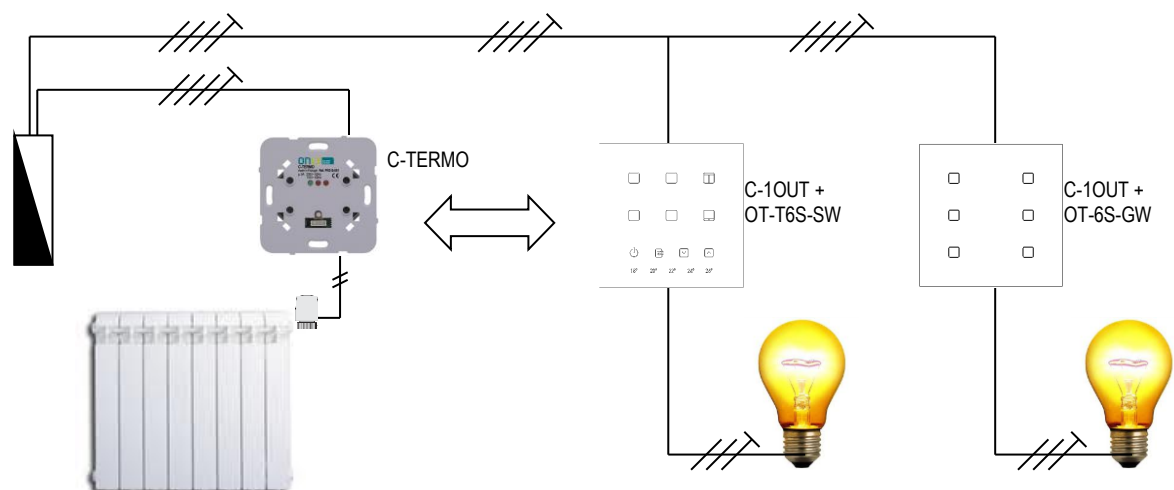

Fig.: Installation of the actuator command and thermostatic panel separately.

In both cases the switching is always done in commands for mounting in in-wall boxes.

The thermostatic panel, mixed or not, with or without LCD, and the actuator command that supports it, must be mounted in in-wall boxes at 1.20m height from the floor, allowing like this the most correct measurement of the temperature and the best readability of the display.

The must be one circuit per floor for climatization protected by a 6 amps circuit breaker.

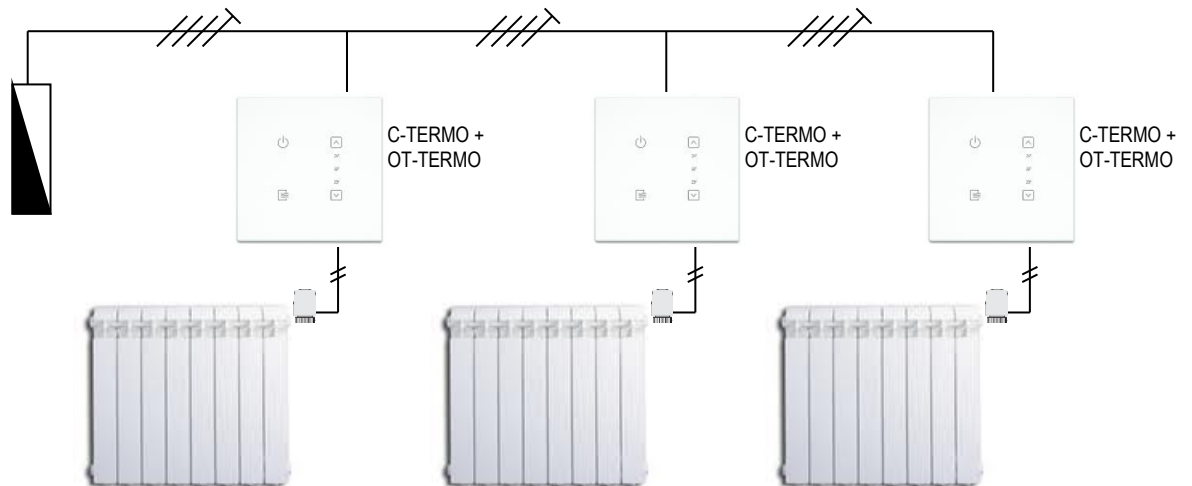

Fig: climatization by water radiators

This circuit is accompanied by the automation BUS line to allow communication with the rest of the system. The supply for the whole system should come from this circuit, including electrovalves and fan coil units, and never from other circuits.

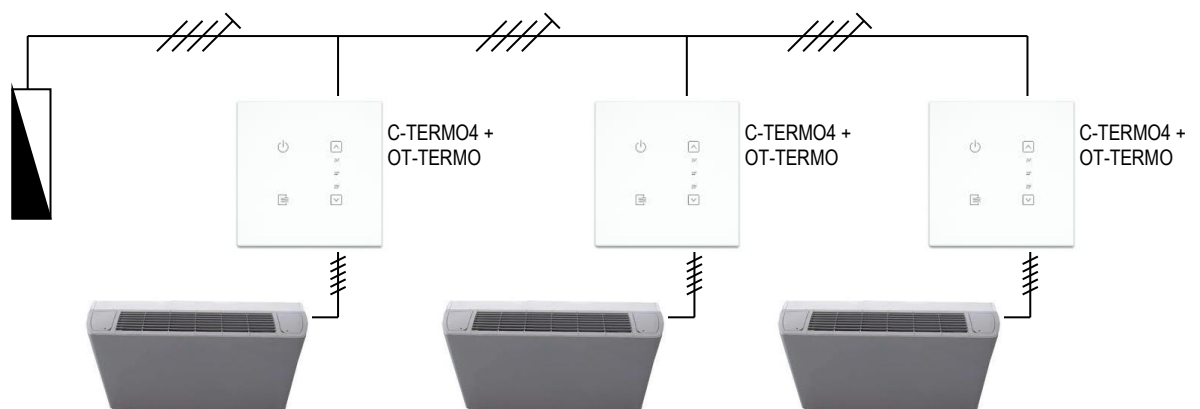

Fig: climatization by fan coil units

The ONLY thermostats can command more than one machine for the same room, e.g., a radiator for heating and fan coil unit for heating and cooling. The client can choose to heat with one, with the other or with both, being able to switch on both when desired.

In this case the architecture of the installation is as follows:

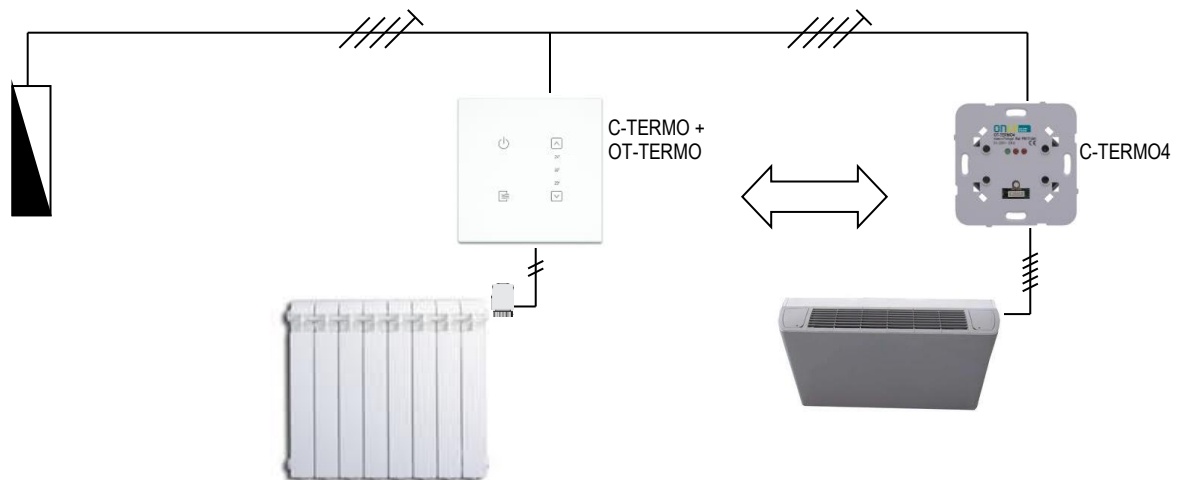
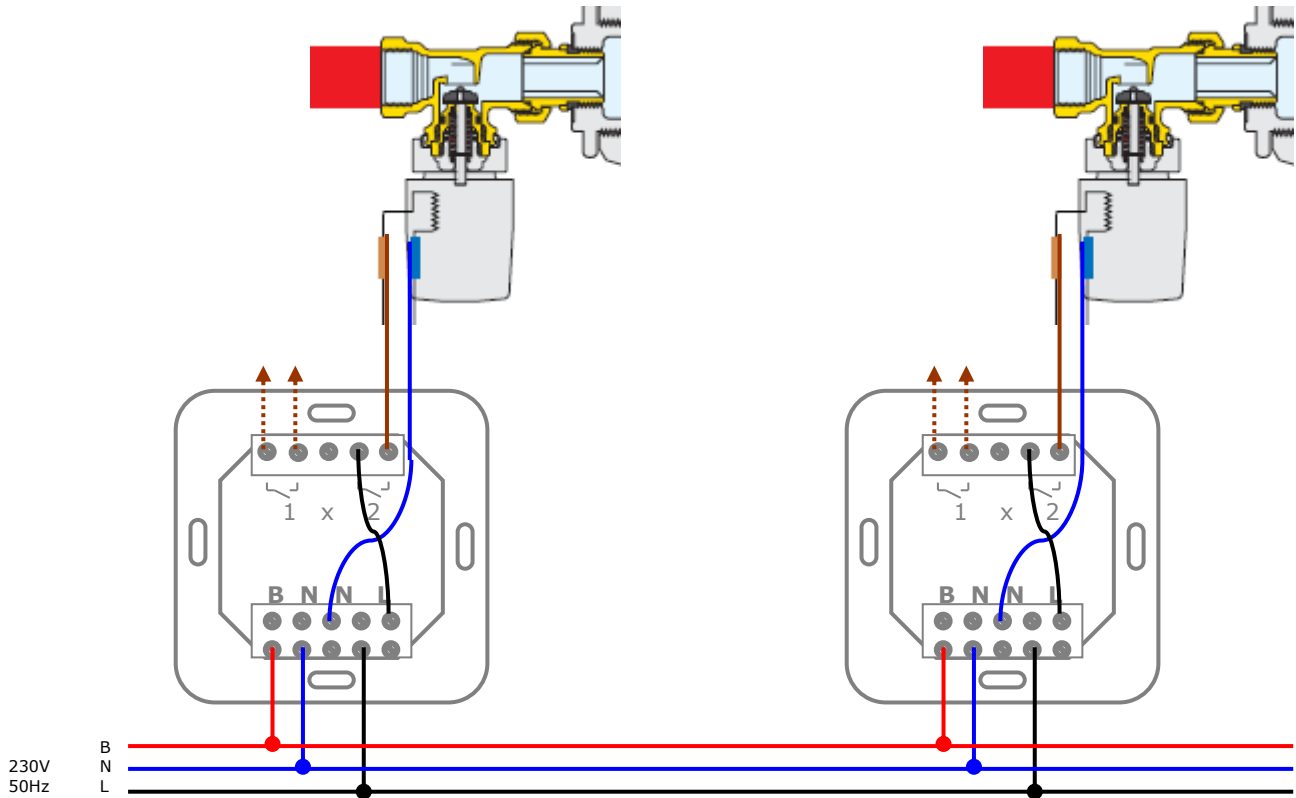

Fig: Thermostat controlling 2 machines

The thermostat that controls directly the radiator (C-TERMO + OT-TERMO) has a command unit for fan coil (C-TERMO4) associated that is controlled as desired by the customer.

CONNECTION AND PROTECTIONS

There should be a specific circuit for the Climatization that supplies all the machines and thermostats of the system. The ONLY thermostats must be protected with a 6 ampere circuit breaker. In this case the connections are as follows:



The valves must always be connected to output 2 of the commands. The outputs 1 of the various thermo commands can be connected in parallel to command e.g. a boiler or heat pump. As an alternative you can use a normal output from another command (e.g. D-4OUT) to command the boiler or heat pump, associating this output to the various thermo commands.

In case of control of fan coil units the connection scheme is as follows:

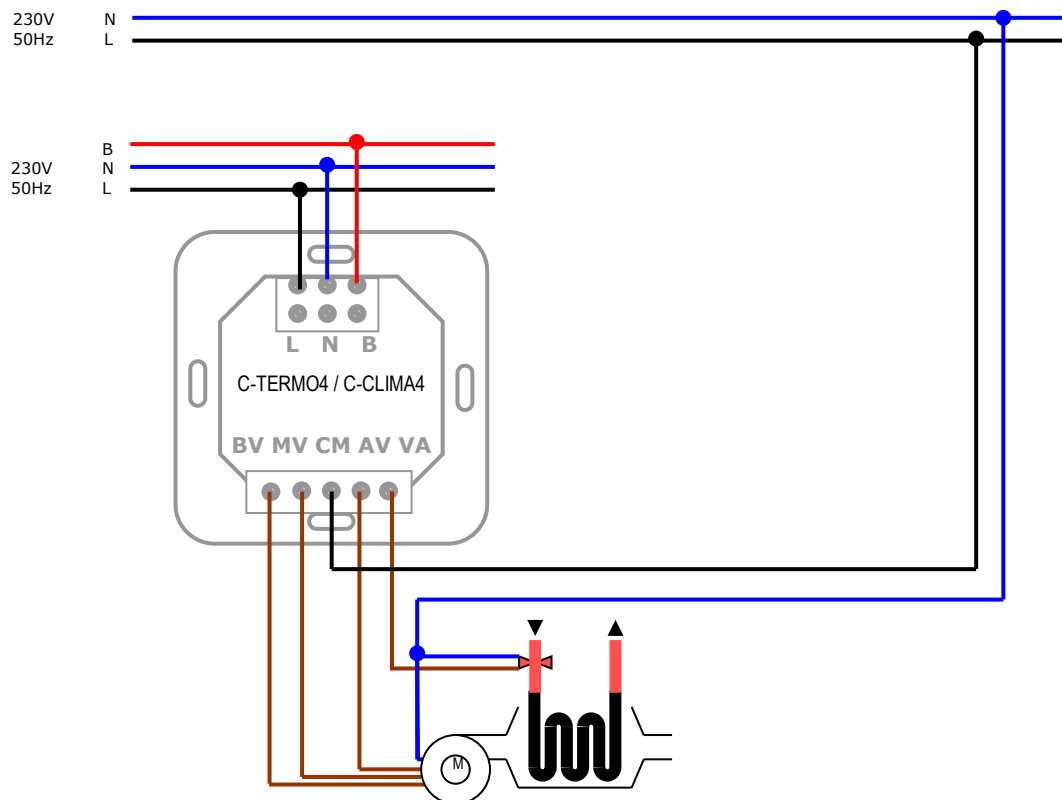



It is recommend the use of two separated power lines, one for the Thermostat and another one for the fan coil unit.

CONFIGURATION

The programmable thermostats must be configured for the application. This configuration is made as follows:

C-TERMO and C-CLIMA

- 1.) Hold the PROG key pressed for 2 seconds
 - 2.) Press the  key:
 - You will hear a BEEP (mode 1)
 - 3.) Select the desired mode with the PROG key
 - 4.) Confirm with the  key.
- The possible modes are:



Mode	R1	Relays	R2
1	Heating		Heating
2	Cooling		Cooling
3	Heating		Cooling
4	Heating + Cooling		Heating + Cooling
5	Switch on when ON		Heating + Cooling
6	Switch on with unit		proporcional Heating

The different modes are for the following type of climatization:

Mode	Type
1	Heating only with radiators and boiler
2	Cooling only (indiscriminated machine)
3	Heating and Cooling with 2 different machines
4	1 speed fan coil (ventilation only when heating or cooling)
5	1 speed fan coil (ventilation when climatization is on)
6	Floor heating by water

This unit is prepared to control two machines: one local via the relays and one remote, controlled by C-TERMO4 command.

Proceed as follows to configure the operation type:

- 1.) Hold the PROG key pressed for 2 seconds
- 2.) Press the key :
 - you will hear a BEEP (operation type 1)
- 3.) Select the desired type with the PROG key
- 4.) Confirm with .

The possible operation types are:

Mode	Operation
1	Operation only with local machine
2	Operation only with remote machine
3	Operation with both machines

To associate a C-TERMO4 to this unit, proceed as follows:

- 1.) Press the PROG key on the C-TERMO4
 - 3 LED's light up.
- 2.) Press the  key on the OT-CLIMA or OT-TERMO

C-TERMO4 and C-CLIMA4

- 1.) Hold the PROG key pressed for 2 seconds
- 2.) Press the ⏻ key:
- you will hear a BEEP (mode 1)
- 3.) Select the desired mode with the PROG key
- 4.) Confirm with the ⏻ key.

The possible modes are:

Mode	BV,MV,AV	Relays	VA
1	Switch on when ON	Heating + Cooling	
2	Heating + Cooling	Heating + Cooling	
3	Heating + Cooling	Cycle selection	

The different modes are for the following type of climatization:

Mode	Type
1	3 speed fan coil (ventilation when climatization is on)
2	3 speed fan coil (ventilation only when heating or cooling)
3	DAIKIN air conditioning with KRP413A plate